

# Dell™ Inspiron™ 1564 Service Manual

[Before You Begin](#)

[Battery](#)

[Optical Drive](#)

[Module Cover](#)

[Coin-Cell Battery](#)

[Memory Module\(s\)](#)

[Wireless Mini-Card](#)

[Hard Drive](#)

[Power Button Panel](#)

[Keyboard](#)

[Palm Rest](#)

[Internal Card With Bluetooth® Wireless Technology](#)

[Processor Fan](#)

[USB/Audio Board](#)

[Optical Drive Board](#)

[Microphone](#)

[AC Adapter Connector](#)

[System Board](#)

[Processor Heat Sink](#)

[Processor Module](#)

[Speakers](#)

[Battery Latch Assembly](#)



[Display](#)

[Camera Module](#)

[Flashing the BIOS](#)

---

## Notes, Cautions, and Warnings

-  **NOTE:** A NOTE indicates important information that helps you make better use of your computer.
-  **CAUTION:** A CAUTION indicates either potential damage to hardware or loss of data and tells you how to avoid the problem.
-  **WARNING:** A WARNING indicates a potential for property damage, personal injury, or death.

---

Information in this document is subject to change without notice.  
© 2009 Dell Inc. All rights reserved.

Reproduction of these materials in any manner whatsoever without the written permission of Dell Inc. is strictly forbidden.

Trademarks used in this text: *Dell*, the *DELL* logo, and *Inspiron* are trademarks of Dell Inc.; *Bluetooth* is a registered trademark owned by Bluetooth SIG, Inc. and is used by Dell under license; *Microsoft*, *Windows*, *Windows Vista*, and the *Windows Vista* start button logo are either trademarks or registered trademarks of Microsoft Corporation in the United States and/or other countries.

Other trademarks and trade names may be used in this document to refer to either the entities claiming the marks and names or their products. Dell Inc. disclaims any proprietary interest in trademarks and trade names other than its own.

December 2009 Rev. A00

Regulatory model: P08F series  
Regulatory type: P08F001

## AC Adapter Connector

### Dell™ Inspiron™ 1564 Service Manual

- [Removing the AC Adapter Connector](#)
- [Replacing the AC Adapter Connector](#)

- ⚠ WARNING:** Before working inside your computer, read the safety information that shipped with your computer. For additional safety best practices information, see the Regulatory Compliance Homepage at [www.dell.com/regulatory\\_compliance](http://www.dell.com/regulatory_compliance).
- ⚠ CAUTION:** Only a certified service technician should perform repairs on your computer. Damage due to servicing that is not authorized by Dell™ is not covered by your warranty.
- ⚠ CAUTION:** To avoid electrostatic discharge, ground yourself by using a wrist grounding strap or by periodically touching an unpainted metal surface.
- ⚠ CAUTION:** To help prevent damage to the system board, remove the main battery (see [Removing the Battery](#)) before working inside the computer.
- 

## Removing the AC Adapter Connector

1. Follow the procedures in [Before You Begin](#).
2. Remove the battery (see [Removing the Battery](#)).
3. Remove the optical drive (see [Removing the Optical Drive](#)).
4. Remove the module cover (see [Removing the Module Cover](#)).
5. Remove the power button panel (see [Removing the Power Button Panel](#)).
6. Remove the keyboard (see [Removing the Keyboard](#)).
7. Remove the palm rest (see [Removing the Palm Rest](#)).
8. Disconnect the AC adapter connector cable from the connector on the system board.
9. Remove the screw that secures the AC adapter connector to the computer base.
10. Lift the AC adapter connector out of the computer base.

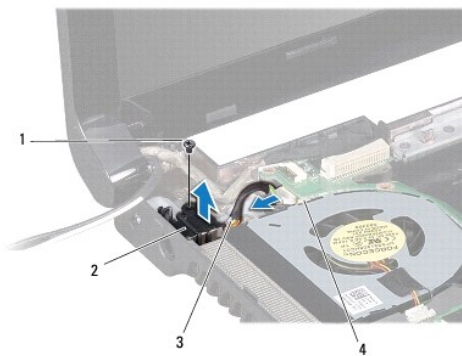

1	screw	2	AC adapter connector
3	AC adapter connector cable	4	connector on the system board

---

## Replacing the AC Adapter Connector

1. Follow the procedures in [Before You Begin](#).

2. Place the AC adapter connector in the computer base.
3. Replace the screw that secures the AC adapter connector to the computer base.
4. Connect the AC adapter connector cable to the connector on the system board.
5. Replace the palm rest (see [Replacing the Palm Rest](#)).
6. Replace the keyboard (see [Replacing the Keyboard](#)).
7. Replace the power button panel (see [Replacing the Power Button Panel](#)).
8. Replace the module cover (see [Replacing the Module Cover](#)).
9. Replace the optical drive (see [Replacing the Optical Drive](#)).
10. Replace the battery (see [Replacing the Battery](#)).

 **CAUTION:** Before turning on the computer, replace all screws and ensure that no stray screws remain inside the computer. Failure to do so may result in damage to the computer.

---

[Back to Contents Page](#)

## Battery

### Dell™ Inspiron™ 1564 Service Manual

- [Removing the Battery](#)
- [Replacing the Battery](#)

- ⚠ WARNING:** Before working inside your computer, read the safety information that shipped with your computer. For additional safety best practices information, see the Regulatory Compliance Homepage at [www.dell.com/regulatory\\_compliance](http://www.dell.com/regulatory_compliance).
- ⚠ CAUTION:** Only a certified service technician should perform repairs on your computer. Damage due to servicing that is not authorized by Dell™ is not covered by your warranty.
- ⚠ CAUTION:** To avoid electrostatic discharge, ground yourself by using a wrist grounding strap or by periodically touching an unpainted metal surface.
- ⚠ CAUTION:** To avoid damage to the computer, use only the battery designed for this particular Dell computer. Do not use batteries designed for other Dell computers.
- 

## Removing the Battery

1. Follow the procedures in [Before You Begin](#).
2. Turn the computer upside down on a clean, flat surface.
3. Slide and click the battery release latch.
4. Slide the battery out of the battery bay.

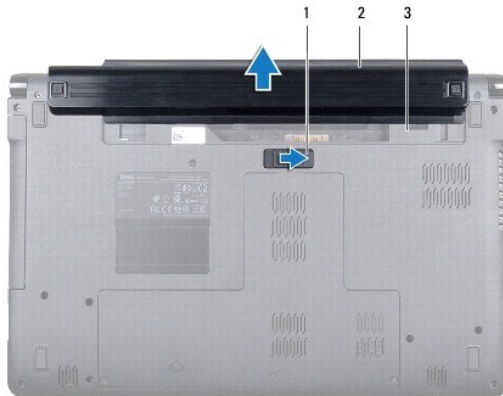

1	battery release latch	2	battery
3	battery bay		

---

## Replacing the Battery

1. Slide the battery into the battery bay, and push to click the battery into place.
-

[Back to Contents Page](#)

## Before You Begin

### Dell™ Inspiron™ 1564 Service Manual

- [Recommended Tools](#)
- [Turning Off Your Computer](#)
- [Before Working Inside Your Computer](#)

This manual provides procedures for removing and installing components in your computer. Unless otherwise noted, each procedure assumes that the following conditions exist:

- 1 You have performed the steps in [Turning Off Your Computer](#) and [Before Working Inside Your Computer](#).
- 1 You have read the safety information that shipped with your computer.
- 1 A component can be replaced or—if purchased separately—installed by performing the removal procedure in the reverse order.

---

## Recommended Tools

The procedures in this document may require the following tools:

- 1 small Phillips screwdriver
- 1 small flat-blade screwdriver
- 1 plastic scribe
- 1 BIOS executable update program available at [support.dell.com](http://support.dell.com)

---

## Turning Off Your Computer

 **CAUTION:** To avoid losing data, save and close all open files and exit all open programs before you turn off your computer.

1. Save and close all open files and exit all open programs.
2. Turn off the computer:

In Microsoft® Windows Vista®, click **Start**  , click the arrow  , and then click **Shut Down**.

In Microsoft Windows® 7, click **Start**  and then click **Shut Down**.

The computer turns off after the operating system shutdown process finishes.

3. Ensure that the computer is turned off. If your computer did not automatically turn off when you shut down the operating system, press and hold the power button until the computer turns off.

---

## Before Working Inside Your Computer

Use the following safety guidelines to help protect your computer from potential damage and to help to ensure your own personal safety.

 **WARNING:** Before working inside your computer, read the safety information that shipped with your computer. For additional safety best practices information, see the Regulatory Compliance Homepage at [www.dell.com/regulatory\\_compliance](http://www.dell.com/regulatory_compliance).

 **CAUTION:** Only a certified service technician should perform repairs on your computer. Damage due to servicing that is not authorized by Dell is not covered by your warranty.

 **CAUTION:** Handle components and cards with care. Do not touch the components or contacts on a card. Hold a card by its edges or by its metal mounting bracket. Hold a component such as a processor by its edges, not by its pins.

 **CAUTION:** When you disconnect a cable, pull on its connector or on its pull-tab, not on the cable itself. Some cables have connectors with locking tabs; if you are disconnecting this type of cable, press in on the locking tabs before you disconnect the cable. As you pull connectors apart, keep them evenly aligned to avoid bending any connector pins. Also, before you connect a cable, ensure that both connectors are correctly oriented and aligned.

 **CAUTION:** To avoid damaging the computer, perform the following steps before you begin working inside the computer.

1. Ensure that the work surface is flat and clean to prevent the computer cover from being scratched.
2. Turn off your computer (see [Turning Off Your Computer](#)) and all attached devices.

 **CAUTION:** To disconnect a network cable, first unplug the cable from your computer and then unplug the cable from the network device.

3. Disconnect all telephone or network cables from the computer.
4. Eject the card from the 7-in-1 memory card reader, if applicable.
5. Disconnect your computer and all attached devices from their electrical outlets.
6. Disconnect all attached devices from your computer.

 **CAUTION:** To help prevent damage to the system board, remove the main battery (see [Removing the Battery](#)) before working inside the computer.

7. Remove the battery (see [Removing the Battery](#)).
8. Open the computer and press the power button to ground the system board.

---

[Back to Contents Page](#)

## Flashing the BIOS

### Dell™ Inspiron™ 1564 Service Manual

1. Turn on the computer.
2. Go to [support.dell.com/support/downloads](http://support.dell.com/support/downloads).
3. Click **Select Model**.
4. Locate the BIOS update file for your computer:

 **NOTE:** The Service Tag for your computer is located at the bottom of the computer.

If you have your computer's Service Tag:

- a. Click **Enter a Service Tag**.
- b. Enter your computer's Service Tag in the **Enter a service tag:** field, click **Go**, and proceed to [step 5](#).

If you do not have your computer's Service Tag:

- a. Select the type of product in the **Select Your Product Family** list.
- b. Select the product brand in the **Select Your Product Line** list.
- c. Select the product model number in the **Select Your Product Model** list.

 **NOTE:** If you have selected a different model and want to start over again, click **Start Over** on the top right of the menu.

- d. Click **Confirm**.
5. A list of results appear on the screen. Click **BIOS**.
  6. Click **Download Now** to download the latest BIOS file.  
The **File Download** window appears.
  7. Click **Save** to save the file on your desktop. The file downloads to your desktop.
  8. Click **Close** if the **Download Complete** window appears.  
The file icon appears on your desktop and is titled the same as the downloaded BIOS update file.
  9. Double-click the file icon on the desktop and follow the instructions on the screen.

## Internal Card With Bluetooth® Wireless Technology

### Dell™ Inspiron™ 1564 Service Manual

- [Removing the Bluetooth Card](#)
- [Replacing the Bluetooth Card](#)

- ⚠ WARNING:** Before working inside your computer, read the safety information that shipped with your computer. For additional safety best practices information, see the Regulatory Compliance Homepage at [www.dell.com/regulatory\\_compliance](http://www.dell.com/regulatory_compliance).
- ⚠ CAUTION:** Only a certified service technician should perform repairs on your computer. Damage due to servicing that is not authorized by Dell™ is not covered by your warranty.
- ⚠ CAUTION:** To avoid electrostatic discharge, ground yourself by using a wrist grounding strap or by periodically touching an unpainted metal surface.
- ⚠ CAUTION:** To help prevent damage to the system board, remove the main battery (see [Removing the Battery](#)) before working inside the computer.

If you ordered a card with Bluetooth wireless technology with your computer, the card is already installed.

---

## Removing the Bluetooth Card

1. Follow the procedures in [Before You Begin](#).
2. Remove the battery (see [Removing the Battery](#)).
3. Remove the optical drive (see [Removing the Optical Drive](#)).
4. Remove the module cover (see [Removing the Module Cover](#)).
5. Remove the power button panel (see [Removing the Power Button Panel](#)).
6. Remove the keyboard (see [Removing the Keyboard](#)).
7. Remove the palm rest (see [Removing the Palm Rest](#)).
8. Remove the screw that secures the Bluetooth card to the system board.
9. Lift the Bluetooth card to disconnect it from the connector on the system board.

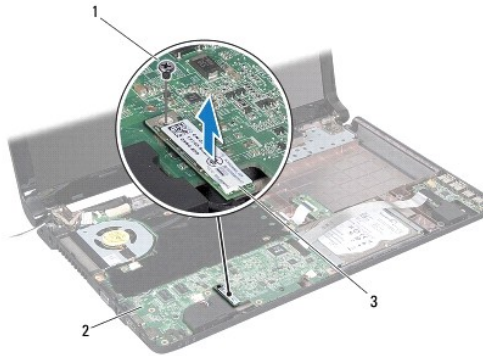

1	screw	2	system board
3	Bluetooth card		

---

## Replacing the Bluetooth Card



1. Follow the procedures in [Before You Begin](#).
2. Align the connector on the Bluetooth card with the connector on the system board, and press down to connect the Bluetooth card to the system board.
3. Replace the screw that secures the Bluetooth card to the system board.
4. Replace the palm rest (see [Replacing the Palm Rest](#)).
5. Replace the keyboard (see [Replacing the Keyboard](#)).
6. Replace the power button panel (see [Replacing the Power Button Panel](#)).
7. Replace the optical drive (see [Replacing the Optical Drive](#)).
8. Replace the module cover (see [Replacing the Module Cover](#)).
9. Replace the battery (see [Replacing the Battery](#)).

 **CAUTION:** Before turning on the computer, replace all screws and ensure that no stray screws remain inside the computer. Failure to do so may result in damage to the computer.

---

[Back to Contents Page](#)

## Camera Module

### Dell™ Inspiron™ 1564 Service Manual

- [Removing the Camera Module](#)
- [Replacing the Camera Module](#)

- ⚠ WARNING:** Before working inside your computer, read the safety information that shipped with your computer. For additional safety best practices information, see the Regulatory Compliance Homepage at [www.dell.com/regulatory\\_compliance](http://www.dell.com/regulatory_compliance).
- ⚠ CAUTION:** Only a certified service technician should perform repairs on your computer. Damage due to servicing that is not authorized by Dell™ is not covered by your warranty.
- ⚠ CAUTION:** To avoid electrostatic discharge, ground yourself by using a wrist grounding strap or by periodically touching an unpainted metal surface (such as a connector on the back of the computer).
- ⚠ CAUTION:** To help prevent damage to the system board, remove the main battery (see [Removing the Battery](#)) before working inside the computer.
- 

## Removing the Camera Module

1. Follow the procedures in [Before You Begin](#).
2. Remove the battery (see [Removing the Battery](#)).
3. Remove the display assembly (see [Removing the Display Assembly](#)).
4. Remove the display bezel (see [Removing the Display Bezel](#)).
5. Remove the display panel (see [Removing the Display Panel](#)).
6. Peel the camera module off the display cover.
7. Remove the tape that secures the camera cable to the camera module.

**📌 NOTE:** The color of the tape on the camera module may vary depending on your computer model.

8. Disconnect the camera cable from the camera module.

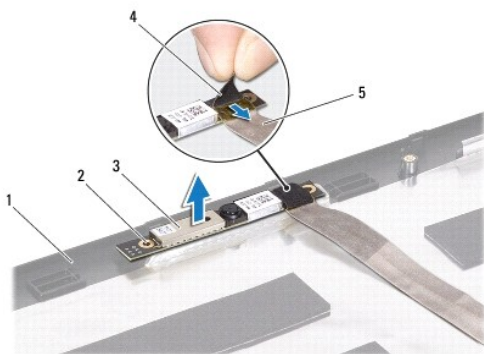

1	display cover	2	alignment posts (2)
3	camera module	4	tape
5	camera cable		

---

## Replacing the Camera Module

1. Follow the procedures in [Before You Begin](#).
2. Connect the camera cable to the connector on the camera module.
3. Replace the tape to secure the camera cable to the camera module.
4. Use the alignment posts to place the camera module on the display cover.
5. Press down on the camera module to secure it to the display cover.
6. Replace the display panel (see [Replacing the Display Panel](#)).
7. Replace the display bezel (see [Replacing the Display Bezel](#)).
8. Replace the display assembly (see [Replacing the Display Assembly](#)).
9. Replace the battery (see [Replacing the Battery](#)).

 **CAUTION:** Before turning on the computer, replace all screws and ensure that no stray screws remain inside the computer. Failure to do so may result in damage to the computer.

---

[Back to Contents Page](#)

## Coin-Cell Battery

### Dell™ Inspiron™ 1564 Service Manual

- [Removing the Coin-Cell Battery](#)
- [Replacing the Coin-Cell Battery](#)

- ⚠ WARNING:** Before working inside your computer, read the safety information that shipped with your computer. For additional safety best practices information, see the Regulatory Compliance Homepage at [www.dell.com/regulatory\\_compliance](http://www.dell.com/regulatory_compliance).
- ⚠ CAUTION:** Only a certified service technician should perform repairs on your computer. Damage due to servicing that is not authorized by Dell™ is not covered by your warranty.
- ⚠ CAUTION:** To avoid electrostatic discharge, ground yourself by using a wrist grounding strap or by periodically touching an unpainted metal surface.
- ⚠ CAUTION:** To help prevent damage to the system board, remove the main battery (see [Removing the Battery](#)) before working inside the computer.
- 

## Removing the Coin-Cell Battery

1. Follow the procedures in [Before You Begin](#).
2. Remove the battery (see [Removing the Battery](#)).
3. Remove the module cover (see [Removing the Module Cover](#)).
4. Use a plastic scribe to pry the coin-cell battery out of the battery socket on the system board.

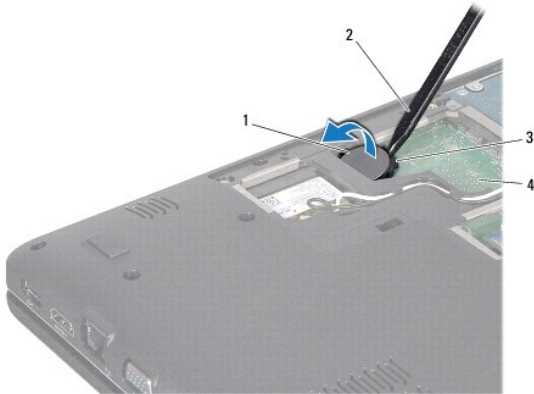

1	coin-cell battery	2	plastic scribe
3	battery socket	4	system board

---

## Replacing the Coin-Cell Battery

1. Follow the procedures in [Before You Begin](#).
2. With the positive side up, snap the coin-cell battery into the battery socket on the system board.
3. Replace the module cover (see [Replacing the Module Cover](#)).
4. Replace the battery (see [Replacing the Battery](#)).

- ⚠ CAUTION:** Before turning on the computer, replace all screws and ensure that no stray screws remain inside the computer. Failure to do so may result in damage to the computer.
-

[Back to Contents Page](#)

## Module Cover

### Dell™ Inspiron™ 1564 Service Manual

- [Removing the Module Cover](#)
- [Replacing the Module Cover](#)

- ⚠ WARNING:** Before working inside your computer, read the safety information that shipped with your computer. For additional safety best practices information, see the Regulatory Compliance Homepage at [www.dell.com/regulatory\\_compliance](http://www.dell.com/regulatory_compliance).
- ⚠ CAUTION:** Only a certified service technician should perform repairs on your computer. Damage due to servicing that is not authorized by Dell™ is not covered by your warranty.
- ⚠ CAUTION:** To avoid electrostatic discharge, ground yourself by using a wrist grounding strap or by periodically touching an unpainted metal surface (such as the back panel) on the computer.
- ⚠ CAUTION:** To help prevent damage to the system board, remove the main battery (see [Removing the Battery](#)) before working inside the computer.
- 

## Removing the Module Cover

1. Follow the procedures in [Before You Begin](#).
2. Remove the battery (see [Removing the Battery](#)).
3. Loosen the three captive screws that secure the module cover to the computer base.
4. Lift the module cover up at an angle to carefully disengage it from the computer base.

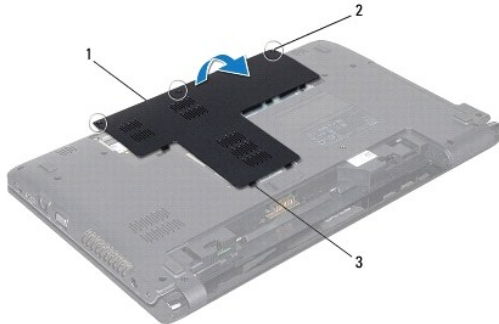

1	module cover	2	captive screws (3)
3	module cover tabs (11)		

---

## Replacing the Module Cover

1. Follow the procedures in [Before You Begin](#).
  2. Align the tabs on the module cover with the slots on the computer base and gently snap the module cover into place.
  3. Tighten the three captive screws that secure the module cover to the computer base.
  4. Replace the battery (see [Replacing the Battery](#)).
-

## Processor Module

### Dell™ Inspiron™ 1564 Service Manual

- [Removing the Processor Module](#)
- [Replacing the Processor Module](#)

- ⚠ WARNING:** Before working inside your computer, read the safety information that shipped with your computer. For additional safety best practices information, see the Regulatory Compliance Homepage at [www.dell.com/regulatory\\_compliance](http://www.dell.com/regulatory_compliance).
- ⚠ CAUTION:** Only a certified service technician should perform repairs on your computer. Damage due to servicing that is not authorized by Dell™ is not covered by your warranty.
- ⚠ CAUTION:** To avoid electrostatic discharge, ground yourself by using a wrist grounding strap or by periodically touching an unpainted metal surface (such as a connector on your computer).
- ⚠ CAUTION:** To prevent intermittent contact between the ZIF-socket cam screw and the processor when removing or replacing the processor, press to apply slight pressure to the center of the processor while turning the cam screw.
- ⚠ CAUTION:** To avoid damage to the processor, hold the screwdriver so that it is perpendicular to the processor when turning the cam screw.
- ⚠ CAUTION:** To help prevent damage to the system board, remove the main battery (see [Removing the Battery](#)) before working inside the computer.

## Removing the Processor Module

1. Follow the procedures in [Before You Begin](#).
2. Remove the battery (see [Removing the Battery](#)).
3. Follow the instructions from [step 3](#) to [step 20](#) in [Removing the System Board](#).
4. Remove the processor heat sink (see [Removing the Processor Heat Sink](#)).
5. To loosen the ZIF socket, use a small, flat-blade screwdriver and rotate the ZIF-socket cam screw counterclockwise until it comes to the cam stop.

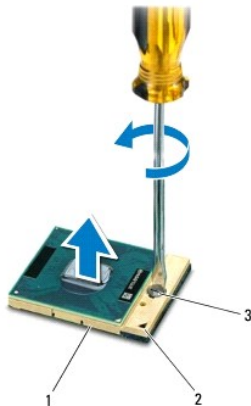

1	ZIF socket	2	pin-1 corner
3	ZIF-socket cam screw		

- ⚠ CAUTION:** To ensure maximum cooling for the processor, do not touch the heat transfer areas on the processor thermal-cooling assembly. The oils in your skin can reduce the heat transfer capability of the thermal pads.
- ⚠ CAUTION:** When removing the processor module, lift the module straight up. Be careful not to bend the pins on the processor module.
6. Lift the processor module from the ZIF socket.

---

## Replacing the Processor Module

 **NOTE:** If a new processor is installed, you will receive a new thermal-cooling assembly, which will include an affixed thermal pad, or you will receive a new thermal pad along with documentation to illustrate proper installation.

1. Follow the procedures in [Before You Begin](#).
2. Align the pin-1 corner of the processor module with the pin-1 corner of the ZIF socket, then place the processor module.

 **NOTE:** The pin-1 corner of the processor module has a triangle that aligns with the triangle on the pin-1 corner of the ZIF socket.

When the processor module is properly seated, all four corners are aligned at the same height. If one or more corners of the module are higher than the others, the module is not seated properly.

 **CAUTION:** To avoid damage to the processor, hold the screwdriver perpendicular to the processor when turning the cam screw.

3. Tighten the ZIF socket by turning the cam screw clockwise to secure the processor module to the system board.
4. Replace the processor heat sink (see [Replacing the Processor Heat Sink](#)).
5. Follow the instructions from [step 4](#) to [step 24](#) in [Replacing the System Board](#).

 **CAUTION:** Before turning on the computer, replace all screws and ensure that no stray screws remain inside the computer. Failure to do so may result in damage to the computer.

---

[Back to Contents Page](#)



## Processor Heat Sink

### Dell™ Inspiron™ 1564 Service Manual

- [Removing the Processor Heat Sink](#)
- [Replacing the Processor Heat Sink](#)

- ⚠ WARNING:** Before working inside your computer, read the safety information that shipped with your computer. For additional safety best practices information, see the Regulatory Compliance Homepage at [www.dell.com/regulatory\\_compliance](http://www.dell.com/regulatory_compliance).
- ⚠ WARNING:** If you remove the processor heat sink from the computer when the heat sink is hot, do not touch the metal housing of the processor heat sink.
- ⚠ CAUTION:** Only a certified service technician should perform repairs on your computer. Damage due to servicing that is not authorized by Dell™ is not covered by your warranty.
- ⚠ CAUTION:** To avoid electrostatic discharge, ground yourself by using a wrist grounding strap or by periodically touching an unpainted metal surface (such as the back panel) on the computer.
- ⚠ CAUTION:** To help prevent damage to the system board, remove the main battery (see [Removing the Battery](#)) before working inside the computer.
- 

## Removing the Processor Heat Sink

1. Follow the procedures in [Before You Begin](#).
2. Remove the battery (see [Removing the Battery](#)).
3. Follow the instructions from [step 3](#) to [step 20](#) in [Removing the System Board](#).

**🔧 NOTE:** Depending on the model of your computer, the heat sink will have either four or six captive screws.

4. Loosen the captive screws that secure the processor heat sink to the system board in sequential order (indicated on the processor heat sink).
5. Remove the processor heat sink from the system board.

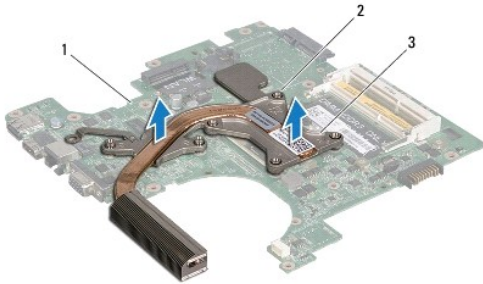

1	system board	2	captive screws
3	processor heat sink		

---

## Replacing the Processor Heat Sink

- 🔧 NOTE:** The original thermal pad can be reused if the original processor and heat sink are reinstalled together. If either the processor or heat sink is replaced, use the thermal pad provided in the kit to ensure that thermal conductivity is achieved.
- 🔧 NOTE:** This procedure assumes that you have already removed the processor heat sink and are ready to replace it.

1. Follow the procedures in [Before You Begin](#).
2. Align the captive screws on the processor heat sink with the screw holes on the system board and tighten the screws in sequential order (indicated on the processor heat sink).

3. Follow the instructions from [step 4](#) to [step 24](#) in [Replacing the System Board](#).

 **CAUTION:** Before turning on the computer, replace all screws and ensure that no stray screws remain inside the computer. Failure to do so may result in damage to the computer.

---

[Back to Contents Page](#)

[Back to Contents Page](#)

## Display

### Dell™ Inspiron™ 1564 Service Manual

- [Display Assembly](#)
- [Display Bezel](#)
- [Display Panel](#)
- [Display Panel Brackets](#)
- [Display Hinges](#)
- [Display Cable](#)

- WARNING:** Before working inside your computer, read the safety information that shipped with your computer. For additional safety best practices information, see the Regulatory Compliance Homepage at [www.dell.com/regulatory\\_compliance](http://www.dell.com/regulatory_compliance).
- CAUTION:** Only a certified service technician should perform repairs on your computer. Damage due to servicing that is not authorized by Dell™ is not covered by your warranty.
- CAUTION:** To avoid electrostatic discharge, ground yourself by using a wrist grounding strap or by periodically touching an unpainted metal surface.
- CAUTION:** To help prevent damage to the system board, remove the main battery (see [Removing the Battery](#)) before working inside the computer.
- 

## Display Assembly

### Removing the Display Assembly

1. Follow the procedures in [Before You Begin](#).
2. Remove the battery (see [Removing the Battery](#)).
3. Remove the module cover (see [Removing the Module Cover](#)).
4. Disconnect the Mini-Card antenna cables (see [step 4](#) in [Removing the Mini-Card](#)).
5. Note of the routing of the Mini-Card antenna cables and remove them from the routing guides on the bottom of the computer.
6. Remove the two screws on the bottom of the computer that secure the display assembly to the computer base.

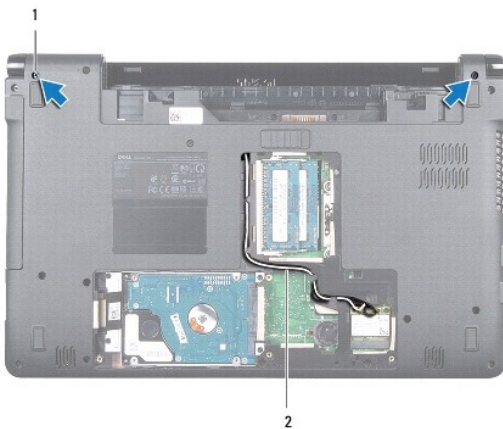

1	screws (2)	2	Mini-Card antenna cable routing
---	------------	---	---------------------------------

7. Remove the power button panel (see [Removing the Power Button Panel](#)).
8. Remove the keyboard (see [Removing the Keyboard](#)).

9. Pull the Mini-Card antenna cables up through the slot in the computer base.
10. Note the routing of the Mini-Card antenna cables and remove them from the routing guides on the palm rest.
11. Disconnect the display cable from the connector on the system board, and remove the display cable grounding screw.

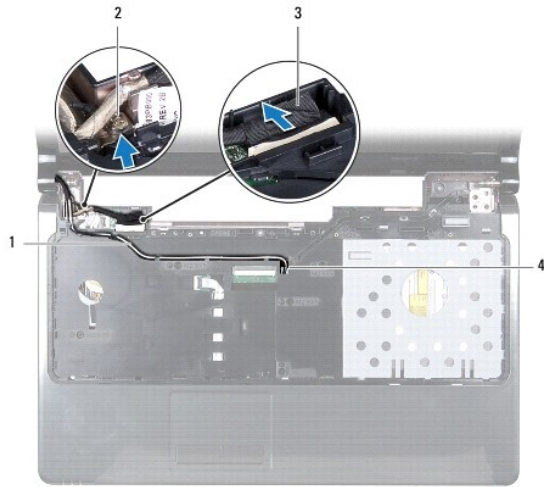

1	Mini-Card antenna cable routing	2	display cable grounding screw
3	display cable	4	slot in computer base

12. Hold the display assembly in place and remove the three screws that secure the display assembly to the computer base.
13. Lift the display assembly off the alignment posts on the computer base.



1	display assembly	2	screws (3)
3	display hinges (2)		

## Replacing the Display Assembly

1. Follow the procedures in [Before You Begin](#).
2. Use the alignment posts to place the display assembly on the computer base.
3. Replace the three screws that secure the display assembly to the computer base.

4. Connect the display cable to the connector on the system board, and replace the display cable grounding screw.
5. Route the Mini-Card antenna cables through the routing guides on the palm rest.
6. Thread the Mini-Card antenna cables through the slot in the computer base.
7. Turn the computer over and replace the two screws that secure the display assembly to the computer base.
8. Route and connect the Mini-Card antenna cables (see [step 5 in Replacing the Mini-Card](#)).
9. Replace the keyboard (see [Replacing the Keyboard](#)).
10. Replace the power button panel (see [Replacing the Power Button Panel](#)).
11. Replace the module cover (see [Replacing the Module Cover](#)).
12. Replace the battery (see [Replacing the Battery](#)).

**CAUTION:** Before turning on the computer, replace all screws and ensure that no stray screws remain inside the computer. Failure to do so may result in damage to the computer.

---

## Display Bezel

### Removing the Display Bezel

**CAUTION:** The display bezel is extremely fragile. Be careful when removing it to prevent damaging the bezel.

1. Follow the procedures in [Before You Begin](#).
2. Remove the display assembly (see [Removing the Display Assembly](#)).
3. Carefully pull up around the inside edges of the display bezel to remove it from the display assembly.



1	display bezel	2	display assembly
---	---------------	---	------------------

### Replacing the Display Bezel

1. Follow the procedures in [Before You Begin](#).
2. Ensure the display cable and Mini-Card antenna cables run through the notch on the left hinge to keep the cables clear of the display bezel.
3. Place the display bezel over the hinges first.
4. Gently press down around the display bezel to snap it into place.

5. Replace the display assembly (see [Replacing the Display Assembly](#)).
6. Replace the battery (see [Replacing the Battery](#)).

**CAUTION:** Before turning on the computer, replace all screws and ensure that no stray screws remain inside the computer. Failure to do so may result in damage to the computer.

## Display Panel

### Removing the Display Panel

1. Follow the procedures in [Before You Begin](#).
2. Remove the display assembly (see [Removing the Display Assembly](#)).
3. Remove the display bezel (see [Removing the Display Bezel](#)).
4. Remove the six screws that secure the display panel to the display cover.
5. Lift the display panel at an angle and hold it in place.



1	screws (6)	2	display panel
---	------------	---	---------------

6. Peel the tape on the display cable and disconnect the display cable from the connector on the display panel.

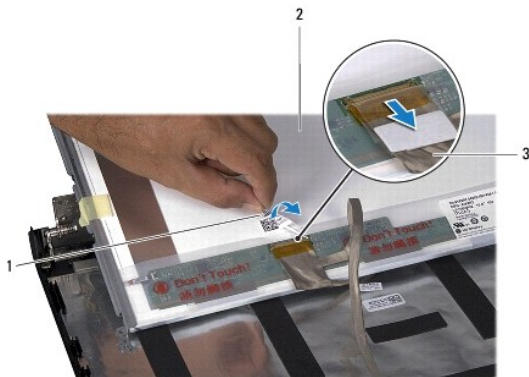

1	tape	2	display panel
3	display cable		

## Replacing the Display Panel

1. Follow the procedures in [Before You Begin](#).
2. Connect the display cable to the connector on the back of the display panel, and replace the tape securing the display cable to the display panel.
3. Use the alignment posts to correctly place the display panel on the display cover.
4. Replace the six screws that secure the display panel to the display cover.
5. Replace the display bezel (see [Replacing the Display Bezel](#)).
6. Replace the display assembly (see [Replacing the Display Assembly](#)).
7. Replace the battery (see [Replacing the Battery](#)).

**CAUTION:** Before turning on the computer, replace all screws and ensure that no stray screws remain inside the computer. Failure to do so may result in damage to the computer.

---

## Display Panel Brackets

### Removing the Display Panel Brackets

1. Follow the procedures in [Before You Begin](#).
2. Remove the display assembly (see [Removing the Display Assembly](#)).
3. Remove the display bezel (see [Removing the Display Bezel](#)).
4. Remove the display panel (see [Removing the Display Panel](#)).
5. Remove the eight screws that secure the display panel brackets to the display panel.

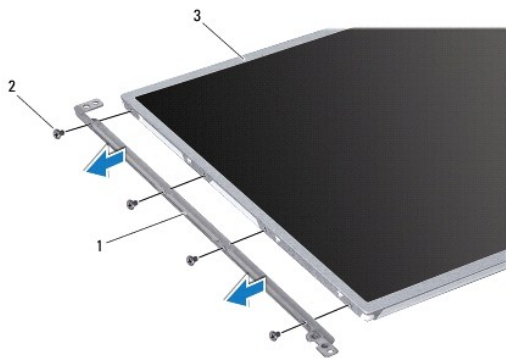

1	display panel brackets (2)	2	screws (8)
3	display panel		

### Replacing the Display Panel Brackets

1. Follow the procedures in [Before You Begin](#).
2. Replace the eight screws that secure the display panel brackets to the display panel.
3. Replace the display panel (see [Replacing the Display Panel](#)).

4. Replace the display bezel (see [Replacing the Display Bezel](#)).
5. Replace the display assembly (see [Replacing the Display Assembly](#)).
6. Replace the battery (see [Replacing the Battery](#)).

**CAUTION:** Before turning on the computer, replace all screws and ensure that no stray screws remain inside the computer. Failure to do so may result in damage to the computer.

---

## Display Hinges

### Removing the Display Hinges

1. Follow the procedures in [Before You Begin](#).
2. Remove the display assembly (see [Removing the Display Assembly](#)).
3. Remove the display bezel (see [Removing the Display Bezel](#)).
4. Remove the display panel (see [Removing the Display Panel](#)).
5. Remove the two screws that secure the display hinges to the display cover.

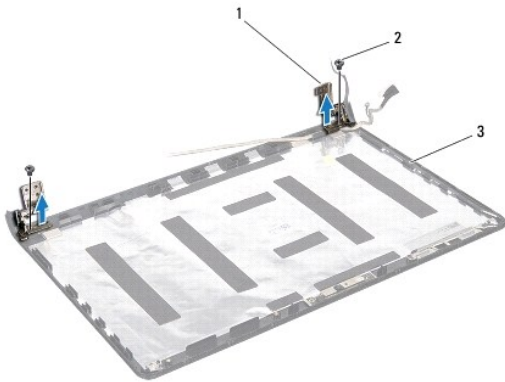

1	display hinges (2)	2	screws (2)
3	display cover		

### Replacing the Display Hinges

1. Follow the procedures in [Before You Begin](#).
2. Use the alignment posts to place the display hinges on the display cover. Ensure the Mini-Card antenna cables and display cable route under the left hinge before replacing the screw.
3. Replace the two screws that secure the display hinges to the display cover.
4. Replace the display panel (see [Replacing the Display Panel](#)).
5. Replace the display bezel (see [Replacing the Display Bezel](#)).
6. Replace the display assembly (see [Replacing the Display Assembly](#)).
7. Replace the battery (see [Replacing the Battery](#)).



 **CAUTION:** Before turning on the computer, replace all screws and ensure that no stray screws remain inside the computer. Failure to do so may result in damage to the computer.

---

## Display Cable

### Removing the Display Cable

1. Follow the procedures in [Before You Begin](#).
2. Remove the display assembly (see [Removing the Display Assembly](#)).
3. Remove the display bezel (see [Removing the Display Bezel](#)).
4. Remove the display panel (see [Removing the Display Panel](#)).
5. Remove the display hinges (see [Removing the Display Hinges](#)).
6. Note the routing of the display cable and remove the display cable from the display cover.

### Replacing the Display Cable

1. Follow the procedures in [Before You Begin](#).
2. Route the display cable through the routing guides on the display cover.
3. Replace the display hinges (see [Replacing the Display Hinges](#)).
4. Replace the display panel (see [Replacing the Display Panel](#)).
5. Replace the display bezel (see [Replacing the Display Bezel](#)).
6. Replace the display assembly (see [Replacing the Display Assembly](#)).
7. Replace the battery (see [Replacing the Battery](#)).

 **CAUTION:** Before turning on the computer, replace all screws and ensure that no stray screws remain inside the computer. Failure to do so may result in damage to the computer.

---

[Back to Contents Page](#)

## Processor Fan

### Dell™ Inspiron™ 1564 Service Manual

- [Removing the Processor Fan](#)
- [Replacing the Processor Fan](#)

- ⚠ WARNING:** Before working inside your computer, read the safety information that shipped with your computer. For additional safety best practices information, see the Regulatory Compliance Homepage at [www.dell.com/regulatory\\_compliance](http://www.dell.com/regulatory_compliance).
- ⚠ CAUTION:** Only a certified service technician should perform repairs on your computer. Damage due to servicing that is not authorized by Dell™ is not covered by your warranty.
- ⚠ CAUTION:** To avoid electrostatic discharge, ground yourself by using a wrist grounding strap or by periodically touching an unpainted metal surface.
- ⚠ CAUTION:** To help prevent damage to the system board, remove the main battery (see [Removing the Battery](#)) before working inside the computer.
- 

## Removing the Processor Fan

1. Follow the procedures in [Before You Begin](#).
2. Remove the battery (see [Removing the Battery](#)).
3. Remove the optical drive (see [Removing the Optical Drive](#)).
4. Remove the module cover (see [Removing the Module Cover](#)).
5. Remove the power button panel (see [Removing the Power Button Panel](#)).
6. Remove the keyboard (see [Removing the Keyboard](#)).
7. Remove the palm rest (see [Removing the Palm Rest](#)).
8. Disconnect the processor fan cable from the connector on the system board.
9. Remove the two screws that secure the processor fan to the computer base.
10. Lift the processor fan out of the computer base.

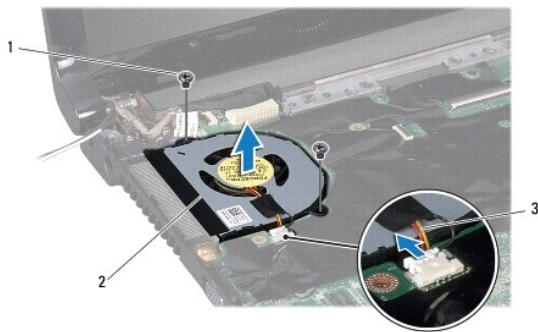

1	screws (2)	2	processor fan
3	processor fan cable		

---

## Replacing the Processor Fan

1. Follow the procedures in [Before You Begin](#).

2. Place the processor fan in the computer base.
3. Replace the two screws that secure the processor fan to the computer base.
4. Connect the processor fan cable to the connector on the system board.
5. Replace the palm rest (see [Replacing the Palm Rest](#)).
6. Replace the keyboard (see [Replacing the Keyboard](#)).
7. Replace the power button panel (see [Replacing the Power Button Panel](#)).
8. Replace the module cover (see [Replacing the Module Cover](#)).
9. Replace the optical drive (see [Replacing the Optical Drive](#)).
10. Replace the battery (see [Replacing the Battery](#)).

 **CAUTION:** Before turning on the computer, replace all screws and ensure that no stray screws remain inside the computer. Failure to do so may result in damage to the computer.

---

[Back to Contents Page](#)

## Hard Drive

### Dell™ Inspiron™ 1564 Service Manual

- [Removing the Hard Drive](#)
- [Replacing the Hard Drive](#)

- ⚠ **WARNING:** Before working inside your computer, read the safety information that shipped with your computer. For additional safety best practices information, see the Regulatory Compliance Homepage at [www.dell.com/regulatory\\_compliance](http://www.dell.com/regulatory_compliance).
- ⚠ **WARNING:** If you remove the hard drive from the computer when the drive is hot, do not touch the metal housing of the hard drive.
- ⚠ **CAUTION:** Only a certified service technician should perform repairs on your computer. Damage due to servicing that is not authorized by Dell is not covered by your warranty.
- ⚠ **CAUTION:** To prevent data loss, turn off your computer (see [Turning Off Your Computer](#)) before removing the hard drive. Do not remove the hard drive while the computer is On or in Sleep state.
- ⚠ **CAUTION:** To help prevent damage to the system board, remove the main battery (see [Removing the Battery](#)) before working inside the computer.
- ⚠ **CAUTION:** Hard drives are extremely fragile. Exercise care when handling the hard drive.
- 🔧 **NOTE:** Dell does not guarantee compatibility or provide support for hard drives from sources other than Dell.
- 🔧 **NOTE:** If you are installing a hard drive from a source other than Dell, you need to install an operating system, drivers, and utilities on the new hard drive (see the *Dell Technology Guide*).

## Removing the Hard Drive

1. Follow the procedures in [Before You Begin](#).
2. Remove the battery (see [Removing the Battery](#)).
3. Remove the module cover (see [Removing the Module Cover](#)).
4. Remove the four screws that secure the hard drive assembly to the computer base.

- ⚠ **CAUTION:** When the hard drive is not in the computer, store it in protective antistatic packaging (see "Protecting Against Electrostatic Discharge" in the safety instructions that shipped with your computer).

5. Using the pull-tab, slide the hard drive assembly towards the left and lift to disconnect the hard drive from the connector on the system board.
6. Lift the hard drive assembly out of the computer base.

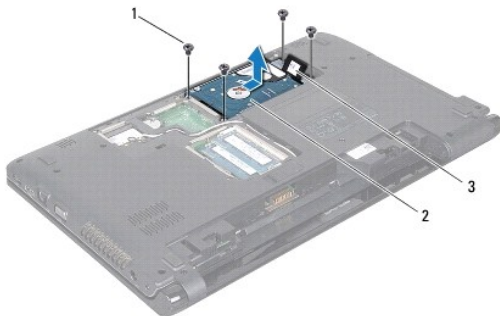

1	screws (4)	2	hard drive assembly
3	pull-tab		

7. Remove the four screws that secure the hard drive bracket to the hard drive.
8. Lift the hard drive out of the hard drive bracket.



1	screws (4)	2	hard drive
3	hard drive bracket		

---

## Replacing the Hard Drive

1. Follow the procedures in [Before You Begin](#).
2. Remove the new hard drive from its packaging.  
Save the original packaging for storing or shipping the hard drive.
3. Place the hard drive in the hard drive bracket.
4. Replace the four screws that secure the hard drive bracket to the hard drive.
5. Place the hard drive assembly in the computer base.
6. Use the pull-tab to push the hard drive assembly into the connector on the system board.
7. Replace the four screws that secure the hard drive assembly to the computer base.
8. Replace the module cover (see [Replacing the Module Cover](#)).
9. Replace the battery (see [Replacing the Battery](#)).

**CAUTION:** Before turning on the computer, replace all screws and ensure that no stray screws remain inside the computer. Failure to do so may result in damage to the computer.

10. Install the operating system for your computer, as needed. See "Restoring Your Operating System" in the *Setup Guide*.
11. Install the drivers and utilities for your computer, as needed. For more information, see the *Dell Technology Guide*.

---

[Back to Contents Page](#)

## Keyboard

### Dell™ Inspiron™ 1564 Service Manual

- [Removing the Keyboard](#)
- [Replacing the Keyboard](#)

- ⚠ WARNING:** Before working inside your computer, read the safety information that shipped with your computer. For additional safety best practices information, see the Regulatory Compliance Homepage at [www.dell.com/regulatory\\_compliance](http://www.dell.com/regulatory_compliance).
- ⚠ CAUTION:** Only a certified service technician should perform repairs on your computer. Damage due to servicing that is not authorized by Dell™ is not covered by your warranty.
- ⚠ CAUTION:** To avoid electrostatic discharge, ground yourself by using a wrist grounding strap or by periodically touching an unpainted metal surface.
- ⚠ CAUTION:** To help prevent damage to the system board, remove the main battery (see [Removing the Battery](#)) before working inside the computer.
- 

## Removing the Keyboard

1. Follow the procedures in [Before You Begin](#).
2. Remove the battery (see [Removing the Battery](#)).
3. Remove the power button panel (see [Removing the Power Button Panel](#)).
4. Remove the three screws that secure the keyboard to the computer base.

**⚠ CAUTION:** The keycaps on the keyboard are fragile, easily dislodged, and time-consuming to replace. Be careful when removing and handling the keyboard.

**⚠ CAUTION:** Be extremely careful when removing and handling the keyboard. Failure to do so could result in scratching the display panel.

5. Lift the keyboard and carefully disengage it from the tabs on the palm rest.
6. Slide the tabs on the keyboard out of the slots on the palm rest.
7. Turn the keyboard over and place it on the palm rest.



1	tabs on the keyboard (6)	2	keyboard
3	screws (3)	4	palm rest

8. Lift the connector latch and slide the keyboard cable out of the connector on the system board.

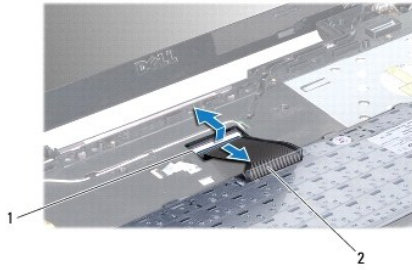

1	connector latch	2	keyboard cable
---	-----------------	---	----------------

9. Lift the keyboard off the palm rest.
- 

## Replacing the Keyboard

1. Follow the procedures in [Before You Begin](#).
2. Place the keyboard upside down on the palm rest.
3. Slide the keyboard cable into the connector on the system board, and press down on the connector latch to secure the cable.
4. Slide the tabs on the keyboard into the slots on the palm rest and lower the keyboard into place.
5. Gently press around the edges of the keyboard to secure the keyboard under the tabs on the palm rest.
6. Replace the three screws that secure the keyboard to the computer base.
7. Replace the power button panel (see [Replacing the Power Button Panel](#)).
8. Replace the battery (see [Replacing the Battery](#)).

**CAUTION:** Before turning on the computer, replace all screws and ensure that no stray screws remain inside the computer. Failure to do so may result in damage to the computer.

---

[Back to Contents Page](#)

## Battery Latch Assembly

### Dell™ Inspiron™ 1564 Service Manual

- [Removing the Battery Latch Assembly](#)
- [Replacing the Battery Latch Assembly](#)

- ⚠ WARNING:** Before working inside your computer, read the safety information that shipped with your computer. For additional safety best practices information, see the Regulatory Compliance Homepage at [www.dell.com/regulatory\\_compliance](http://www.dell.com/regulatory_compliance).
- ⚠ CAUTION:** Only a certified service technician should perform repairs on your computer. Damage due to servicing that is not authorized by Dell™ is not covered by your warranty.
- ⚠ CAUTION:** To avoid electrostatic discharge, ground yourself by using a wrist grounding strap or by periodically touching an unpainted metal surface (such as a connector on the back of the computer).
- ⚠ CAUTION:** To help prevent damage to the system board, remove the main battery (see [Removing the Battery](#)) before working inside the computer.
- 

## Removing the Battery Latch Assembly

1. Follow the procedures in [Before You Begin](#).
2. Remove the battery (see [Removing the Battery](#)).
3. Follow the instructions from [step 3](#) to [step 19](#) in [Removing the System Board](#).
4. Remove the screw that secures the battery release latch to the battery latch assembly.
5. Remove the battery latch spring from the battery latch assembly and the computer base.
6. Remove the battery latch assembly from the computer base.

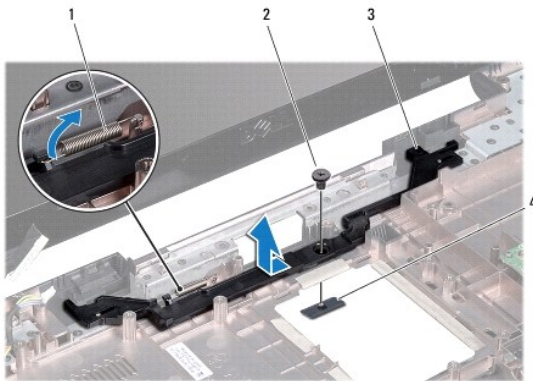

1	battery latch spring	2	screw
3	battery latch assembly	4	battery release latch

---

## Replacing the Battery Latch Assembly

1. Follow the procedures in [Before You Begin](#).
2. Place the battery latch assembly into the computer base.
3. Hook the battery latch spring to the battery latch assembly and then to the computer base.
4. Hold the battery release latch in place and replace the screw that secures the battery release latch to the battery latch assembly.



5. Follow the instructions from [step 5](#) to [step 24](#) in [Replacing the System Board](#).

 **CAUTION:** Before turning on the computer, replace all screws and ensure that no stray screws remain inside the computer. Failure to do so may result in damage to the computer.

---

[Back to Contents Page](#)

## Memory Module(s)

### Dell™ Inspiron™ 1564 Service Manual

- [Removing the Memory Module\(s\)](#)
- [Replacing the Memory Module\(s\)](#)

- ⚠ WARNING:** Before working inside your computer, read the safety information that shipped with your computer. For additional safety best practices information, see the Regulatory Compliance Homepage at [www.dell.com/regulatory\\_compliance](http://www.dell.com/regulatory_compliance).
- ⚠ CAUTION:** Only a certified service technician should perform repairs on your computer. Damage due to servicing that is not authorized by Dell™ is not covered by your warranty.
- ⚠ CAUTION:** To avoid electrostatic discharge, ground yourself by using a wrist grounding strap or by periodically touching an unpainted metal surface (such as a connector on the back of the computer).
- ⚠ CAUTION:** To help prevent damage to the system board, remove the main battery (see [Removing the Battery](#)) before working inside the computer.

You can increase your computer memory by installing memory modules on the system board. See "Basic Specifications" in your *Setup Guide* and *Comprehensive Specifications* at [support.dell.com/manuals](http://support.dell.com/manuals) for information on the memory supported by your computer.

**🔍 NOTE:** Memory modules purchased from Dell™ are covered under your computer warranty.

Your computer has two SODIMM connectors that you can access from the bottom of your computer.

---

## Removing the Memory Module(s)

1. Follow the procedures in [Before You Begin](#).
2. Remove the battery (see [Removing the Battery](#)).
3. Remove the module cover (see [Removing the Module Cover](#)).

- ⚠ CAUTION:** To prevent damage to the memory module connector, do not use tools to spread the memory module securing clips.
4. Use your fingertips to carefully spread apart the securing clips on each end of the memory module connector until the memory module pops up.
  5. Remove the memory module from the memory module connector.

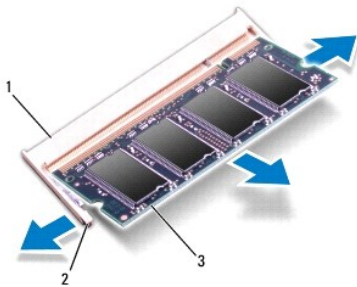

1	memory module connector	2	securing clips (2)
3	memory module		

---

## Replacing the Memory Module(s)

- ⚠ CAUTION:** If you need to install memory modules in two connectors, install a memory module in the lower connector before you install a memory module in the upper connector.

1. Follow the procedures in [Before You Begin](#).
2. Align the notch in the memory module with the tab in the memory module connector.
3. Slide the memory module firmly into the slot at a 45-degree angle, and press the memory module down until it clicks into place. If you do not hear the click, remove the memory module and reinstall it.

 **NOTE:** If the memory module is not installed properly, the computer may not boot.

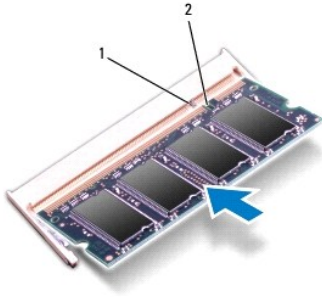

1	tab	2	notch
---	-----	---	-------

4. Replace the module cover (see [Replacing the Module Cover](#)).
5. Replace the battery (see [Replacing the Battery](#)). Connect the AC adapter to your computer and an electrical outlet.

 **CAUTION:** Before turning on the computer, replace all screws and ensure that no stray screws remain inside the computer. Failure to do so may result in damage to the computer.

6. Turn on the computer.

As the computer boots, it detects the memory module(s) and automatically updates the system configuration information.

Confirm the amount of memory installed in the computer:

In Microsoft Windows Vista®, click **Start**  → **Help and Support** → **Dell System Information**.

In Microsoft Windows® 7, click **Start**  → **Control Panel** → **System and Security** → **System**.

---

[Back to Contents Page](#)

## Microphone

### Dell™ Inspiron™ 1564 Service Manual

- [Removing the Microphone](#)
- [Replacing the Microphone](#)

- ⚠ WARNING:** Before working inside your computer, read the safety information that shipped with your computer. For additional safety best practices information, see the Regulatory Compliance Homepage at [www.dell.com/regulatory\\_compliance](http://www.dell.com/regulatory_compliance).
- ⚠ CAUTION:** Only a certified service technician should perform repairs on your computer. Damage due to servicing that is not authorized by Dell™ is not covered by your warranty.
- ⚠ CAUTION:** To avoid electrostatic discharge, ground yourself by using a wrist grounding strap or by periodically touching an unpainted metal surface.
- ⚠ CAUTION:** To help prevent damage to the system board, remove the main battery (see [Removing the Battery](#)) before working inside the computer.
- 

## Removing the Microphone

1. Follow the procedures in [Before You Begin](#).
2. Remove the battery (see [Removing the Battery](#)).
3. Remove the optical drive (see [Removing the Optical Drive](#)).
4. Remove the module cover (see [Removing the Module Cover](#)).
5. Remove the power button panel (see [Removing the Power Button Panel](#)).
6. Remove the keyboard (see [Removing the Keyboard](#)).
7. Remove the palm rest (see [Removing the Palm Rest](#)).
8. Disconnect the microphone cable from the connector on the system board.
9. Gently slide the microphone out of the slot in the computer base.

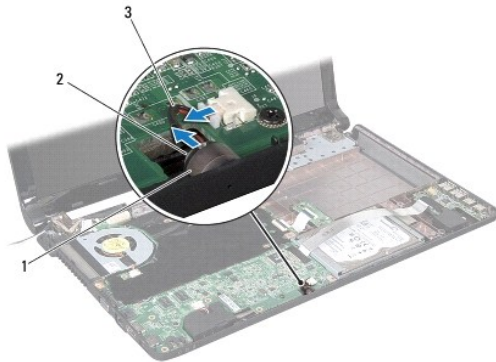

1	slot in computer base	2	microphone
3	microphone cable		

---

## Replacing the Microphone

1. Follow the procedures in [Before You Begin](#).
2. Slide the microphone into the slot in the computer base.

3. Connect the microphone cable to the connector on the system board.
4. Replace the palm rest (see [Replacing the Palm Rest](#)).
5. Replace the keyboard (see [Replacing the Keyboard](#)).
6. Replace the power button panel (see [Replacing the Power Button Panel](#)).
7. Replace the module cover (see [Replacing the Module Cover](#)).
8. Replace the optical drive (see [Replacing the Optical Drive](#)).
9. Replace the battery (see [Replacing the Battery](#)).

 **CAUTION:** Before turning on the computer, replace all screws and ensure that no stray screws remain inside the computer. Failure to do so may result in damage to the computer.

---

[Back to Contents Page](#)

## Wireless Mini-Card

### Dell™ Inspiron™ 1564 Service Manual

- [Removing the Mini-Card](#)
- [Replacing the Mini-Card](#)

- ⚠ WARNING:** Before working inside your computer, read the safety information that shipped with your computer. For additional safety best practices information, see the Regulatory Compliance Homepage at [www.dell.com/regulatory\\_compliance](http://www.dell.com/regulatory_compliance).
- ⚠ CAUTION:** Only a certified service technician should perform repairs on your computer. Damage due to servicing that is not authorized by Dell™ is not covered by your warranty.
- ⚠ CAUTION:** To avoid electrostatic discharge, ground yourself by using a wrist grounding strap or by periodically touching an unpainted metal surface.
- ⚠ CAUTION:** To help prevent damage to the system board, remove the main battery (see [Removing the Battery](#)) before working inside the computer.
- ⚠ CAUTION:** When the Mini-Card is not in the computer, store it in protective antistatic packaging (see "Protecting Against Electrostatic Discharge" in the safety instructions that shipped with your computer).
- 🔧 NOTE:** Dell does not guarantee compatibility or provide support for Mini-Cards from sources other than Dell.
- 🔧 NOTE:** Depending on the configuration of the computer when it was sold, the Mini-Card slot may or may not have a Mini-Card installed in the slot.

If you ordered a wireless Mini-Card with your computer, the card is already installed.

Your computer supports one half Mini-Card slot for the Wireless Local Area Network (WLAN) Mini-Card.

---

## Removing the Mini-Card

1. Follow the procedures in [Before You Begin](#).
2. Remove the battery (see [Removing the Battery](#)).
3. Remove the module cover (see [Removing the Module Cover](#)).
4. Disconnect the antenna cables from the Mini-Card.
5. Remove the screw that secures the Mini-Card to the system board.
6. Lift the Mini-Card out of the connector on the system board.

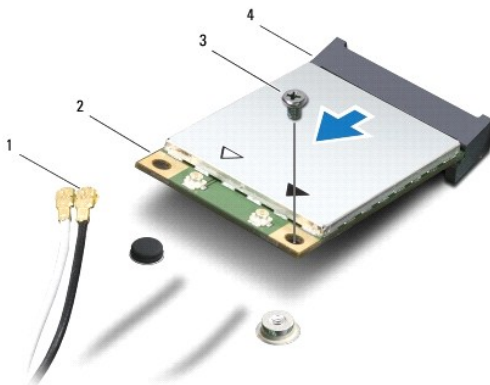

1	antenna cables (2)	2	Mini-Card
3	screw	4	connector on the system board

## Replacing the Mini-Card

1. Follow the procedures in [Before You Begin](#).
2. Remove the new Mini-Card from its packaging.

 **CAUTION:** Use firm and even pressure to slide the card into place. If you use excessive force, you may damage the connector.

 **CAUTION:** The connectors are keyed to ensure correct insertion. If you feel resistance, check the connectors on the card and on the system board, and realign the card.

 **CAUTION:** To avoid damage to the Mini-Card, never place cables under the card.

3. With the label on the Mini-Card facing up, insert it at a 45-degree angle into the appropriate connector on the system board.
4. Press the other end of the Mini-Card down into the slot on the system board and replace the screw that secures the Mini-Card to the system board.
5. Connect the white antenna cable to the main Mini-Card connector labeled with a white triangle. Connect the black antenna cable to the auxiliary Mini-Card connector labeled with a black triangle.
6. Replace the module cover (see [Replacing the Module Cover](#)).
7. Replace the battery (see [Replacing the Battery](#)).

 **CAUTION:** Before turning on the computer, replace all screws and ensure that no stray screws remain inside the computer. Failure to do so may result in damage to the computer.

8. Install the drivers and utilities for your computer, as required. For more information, see the *Dell Technology Guide*.

 **NOTE:** If you are installing a communication card from a source other than Dell, you must install the appropriate drivers and utilities. For more generic driver information, see the *Dell Technology Guide*.

---

[Back to Contents Page](#)

## Optical Drive Board

### Dell™ Inspiron™ 1564 Service Manual

- [Removing the Optical Drive Board](#)
- [Replacing the Optical Drive Board](#)

- ⚠ WARNING:** Before working inside your computer, read the safety information that shipped with your computer. For additional safety best practices information, see the Regulatory Compliance Homepage at [www.dell.com/regulatory\\_compliance](http://www.dell.com/regulatory_compliance).
- ⚠ CAUTION:** Only a certified service technician should perform repairs on your computer. Damage due to servicing that is not authorized by Dell™ is not covered by your warranty.
- ⚠ CAUTION:** To avoid electrostatic discharge, ground yourself by using a wrist grounding strap or by periodically touching an unpainted metal surface.
- ⚠ CAUTION:** To help prevent damage to the system board, remove the main battery (see [Removing the Battery](#)) before working inside the computer.
- 

## Removing the Optical Drive Board

1. Follow the procedures in [Before You Begin](#).
2. Remove the battery (see [Removing the Battery](#)).
3. Remove the optical drive (see [Removing the Optical Drive](#)).
4. Remove the module cover (see [Removing the Module Cover](#)).
5. Remove the power button panel (see [Removing the Power Button Panel](#)).
6. Remove the keyboard (see [Removing the Keyboard](#)).
7. Remove the palm rest (see [Removing the Palm Rest](#)).
8. Lift the connector latch and slide the optical drive board cable out of the connector on the optical drive board.
9. Remove the two screws that secure the optical drive board to the computer base.
10. Lift the optical drive board out of the computer base.

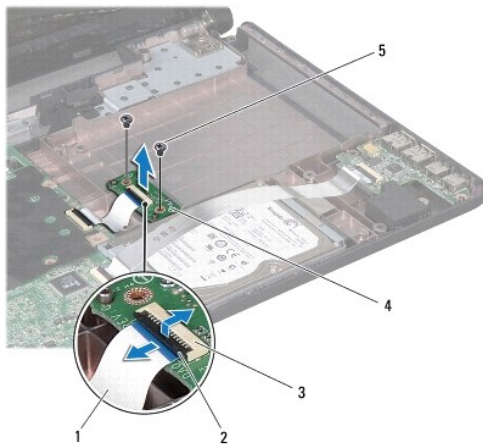

1	optical drive board cable	2	connector latch
3	connector on optical drive board	4	optical drive board
5	screws (2)		

---



## Replacing the Optical Drive Board

1. Follow the procedures in [Before You Begin](#).
2. Use the alignment posts on the computer base to correctly place the optical drive board.
3. Replace the two screws that secure the optical drive board to the computer base.
4. Slide the optical drive board cable into the connector on the optical drive board, and press down on the connector latch to secure the cable.
5. Replace the palm rest (see [Replacing the Palm Rest](#)).
6. Replace the keyboard (see [Replacing the Keyboard](#)).
7. Replace the power button panel (see [Replacing the Power Button Panel](#)).
8. Replace the module cover (see [Replacing the Module Cover](#)).
9. Replace the optical drive (see [Replacing the Optical Drive](#)).
10. Replace the battery (see [Replacing the Battery](#)).

 **CAUTION:** Before turning on the computer, replace all screws and ensure that no stray screws remain inside the computer. Failure to do so may result in damage to the computer.

---

[Back to Contents Page](#)

## Optical Drive

### Dell™ Inspiron™ 1564 Service Manual

- [Removing the Optical Drive](#)
- [Replacing the Optical Drive](#)

- ⚠ WARNING:** Before working inside your computer, read the safety information that shipped with your computer. For additional safety best practices information, see the Regulatory Compliance Homepage at [www.dell.com/regulatory\\_compliance](http://www.dell.com/regulatory_compliance).
- ⚠ CAUTION:** Only a certified service technician should perform repairs on your computer. Damage due to servicing that is not authorized by Dell™ is not covered by your warranty.
- ⚠ CAUTION:** To avoid electrostatic discharge, ground yourself by using a wrist grounding strap or by periodically touching an unpainted metal surface (such as the back panel) on the computer.
- ⚠ CAUTION:** To help prevent damage to the system board, remove the main battery (see [Removing the Battery](#)) before working inside the computer.
- 

## Removing the Optical Drive

1. Follow the procedures in [Before You Begin](#).
2. Remove the battery (see [Removing the Battery](#)).
3. Remove the screw that secures the optical drive to the computer base.
4. Slide the optical drive out of the optical drive bay.

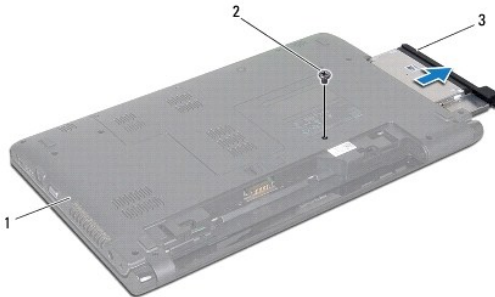

1	computer base	2	screw
3	optical drive		

---

## Replacing the Optical Drive

1. Follow the procedures in [Before You Begin](#).
2. Slide the optical drive into the optical drive bay.
3. Replace the screw that secures the optical drive to the computer base.
4. Replace the battery (see [Replacing the Battery](#)).

- ⚠ CAUTION:** Before turning on the computer, replace all screws and ensure that no stray screws remain inside the computer. Failure to do so may result in damage to the computer.
-



## Palm Rest

### Dell™ Inspiron™ 1564 Service Manual

- [Removing the Palm Rest](#)
- [Replacing the Palm Rest](#)

- ⚠ WARNING:** Before working inside your computer, read the safety information that shipped with your computer. For additional safety best practices information, see the Regulatory Compliance Homepage at [www.dell.com/regulatory\\_compliance](http://www.dell.com/regulatory_compliance).
- ⚠ CAUTION:** To avoid electrostatic discharge, ground yourself by using a wrist grounding strap or by periodically touching an unpainted metal surface.
- ⚠ CAUTION:** Only a certified service technician should perform repairs on your computer. Damage due to servicing that is not authorized by Dell™ is not covered by your warranty.
- ⚠ CAUTION:** To help prevent damage to the system board, remove the main battery (see [Removing the Battery](#)) before working inside the computer.
- 

## Removing the Palm Rest

1. Follow the procedures in [Before You Begin](#).
2. Remove the battery (see [Removing the Battery](#)).
3. Remove the optical drive (see [Removing the Optical Drive](#)).
4. Remove the module cover (see [Removing the Module Cover](#)).
5. Disconnect the Mini-Card antenna cables (see [step 4](#) in [Removing the Mini-Card](#)).
6. Note the routing of the Mini-Card antenna cables and remove them from the routing guides on the bottom of the computer.
7. Remove the fourteen screws that secure the palm rest to the computer base.

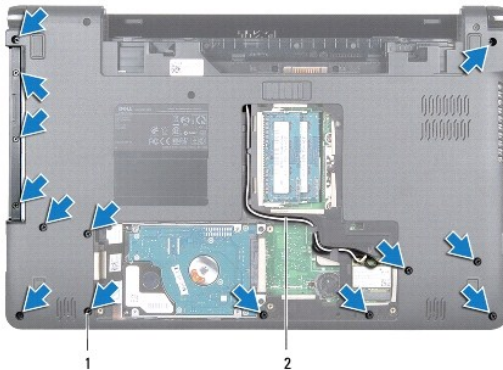

1	screws (14)	2	Mini-Card antenna cable routing
---	-------------	---	---------------------------------

8. Remove the power button panel (see [Removing the Power Button Panel](#)).
9. Remove the keyboard (see [Removing the Keyboard](#)).
10. Lift the connector latch, then pull the pull-tab to disconnect the touch pad cable from the connector on the system board.
11. Pull the Mini-Card antenna cables up through the slot in the computer base.
12. Note the routing of the Mini-Card antenna cables and remove them from the routing guides on the palm rest.
13. Remove the six screws that secure the palm rest to the computer base.

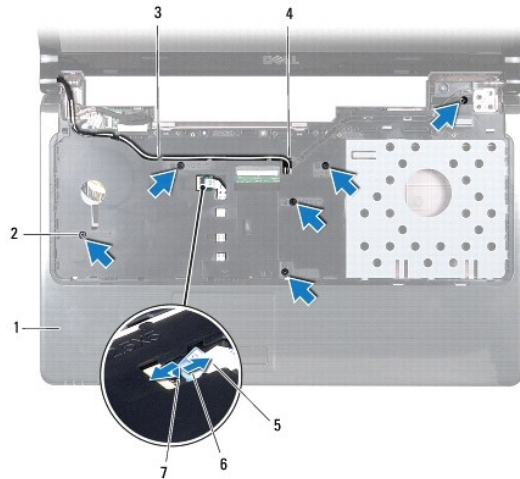

1	palm rest	2	screws (6)
3	Mini-Card antenna cable routing	4	slot in computer base
5	touch pad cable	6	pull-tab
7	connector latch		

**CAUTION:** Carefully separate the palm rest from the computer base to avoid damage to the palm rest.

14. Starting at the right or left of the palm rest, use your fingers to separate the palm rest from the computer base.
15. Lift the palm rest off the computer base.



## Replacing the Palm Rest

1. Follow the procedures in [Before You Begin](#).
2. Align the palm rest on the computer base and snap the palm rest into place.
3. Slide the touch pad cable into the connector on the system board, and press down on the connector latch to secure the cable.
4. Replace the six screws that secure the palm rest to the computer base.
5. Route the Mini-Card antenna cables through the routing guides on the palm rest.
6. Thread the Mini-Card antenna cables through the slot in the computer base.
7. Replace the fourteen screws that secure the palm rest to the computer base.

8. Replace the keyboard (see [Replacing the Keyboard](#)).
9. Replace the power button panel (see [Replacing the Power Button Panel](#)).
10. Route and connect the Mini-Card antenna cables (see [step 5](#) in [Replacing the Mini-Card](#)).
11. Replace the module cover (see [Replacing the Module Cover](#)).
12. Replace the optical drive (see [Replacing the Optical Drive](#)).
13. Replace the battery (see [Replacing the Battery](#)).

 **CAUTION:** Before turning on the computer, replace all screws and ensure that no stray screws remain inside the computer. Failure to do so may result in damage to the computer.

---

[Back to Contents Page](#)

[Back to Contents Page](#)

## Power Button Panel

Dell™ Inspiron™ 1564 Service Manual

- [Removing the Power Button Panel](#)
- [Replacing the Power Button Panel](#)

- ⚠ WARNING:** Before working inside your computer, read the safety information that shipped with your computer. For additional safety best practices information, see the Regulatory Compliance Homepage at [www.dell.com/regulatory\\_compliance](http://www.dell.com/regulatory_compliance).
- ⚠ CAUTION:** Only a certified service technician should perform repairs on your computer. Damage due to servicing that is not authorized by Dell™ is not covered by your warranty.
- ⚠ CAUTION:** To avoid electrostatic discharge, ground yourself by using a wrist grounding strap or by periodically touching an unpainted metal surface.
- ⚠ CAUTION:** To help prevent damage to the system board, remove the main battery (see [Removing the Battery](#)) before working inside the computer.
- 

### Removing the Power Button Panel

1. Follow the procedures in [Before You Begin](#).
2. Remove the battery (see [Removing the Battery](#)).
3. Remove the three screws that secure the power button panel to the computer base.

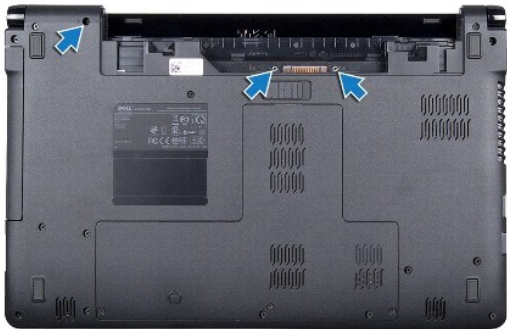

4. Turn the computer over and open the display as far as possible.
- ⚠ CAUTION:** Be extremely careful when removing the power button panel. The panel is very fragile.
5. Between the two hinges, pull up on the power button panel to disengage the tabs from the palm rest.
- ⚠ CAUTION:** To avoid damaging the power button cable, lift the power button panel with extreme care.
6. Lift the connector latch, then pull the pull-tab to disconnect the power button cable from the connector on the system board.
  7. Remove the power button panel from the computer base.

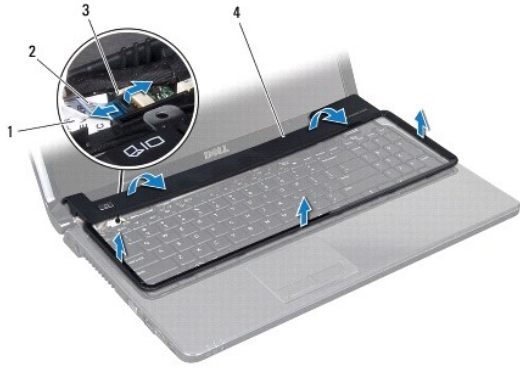

1	power button cable	2	pull-tab
3	connector latch	4	power button panel

---

## Replacing the Power Button Panel

1. Follow the procedures in [Before You Begin](#).
2. Slide the power button cable into the connector on the system board, and press down on the connector latch to secure the cable.
3. Align the tabs on the power button panel with the slots on the palm rest and carefully snap the power button panel into place.
4. Close the computer and turn it over.
5. Replace the three screws that secure the power button panel to the computer base.
6. Replace the battery (see [Replacing the Battery](#)).

**CAUTION:** Before turning on the computer, replace all screws and ensure that no stray screws remain inside the computer. Failure to do so may result in damage to the computer.

---

[Back to Contents Page](#)



## Speakers

### Dell™ Inspiron™ 1564 Service Manual

- [Removing the Speakers](#)
- [Replacing the Speakers](#)

- ⚠ WARNING:** Before working inside your computer, read the safety information that shipped with your computer. For additional safety best practices information, see the Regulatory Compliance Homepage at [www.dell.com/regulatory\\_compliance](http://www.dell.com/regulatory_compliance).
- ⚠ CAUTION:** Only a certified service technician should perform repairs on your computer. Damage due to servicing that is not authorized by Dell™ is not covered by your warranty.
- ⚠ CAUTION:** To avoid electrostatic discharge, ground yourself by using a wrist grounding strap or by periodically touching an unpainted metal surface.
- ⚠ CAUTION:** To help prevent damage to the system board, remove the main battery (see [Removing the Battery](#)) before working inside the computer.
- 

## Removing the Speakers

1. Follow the procedures in [Before You Begin](#).
2. Remove the battery (see [Removing the Battery](#)).
3. Follow the instructions from [step 3](#) to [step 19](#) in [Removing the System Board](#).
4. Remove the five screws that secure the two speakers to the computer base.
5. Note the routing of the speaker cable and remove the speakers and cable from the computer base.

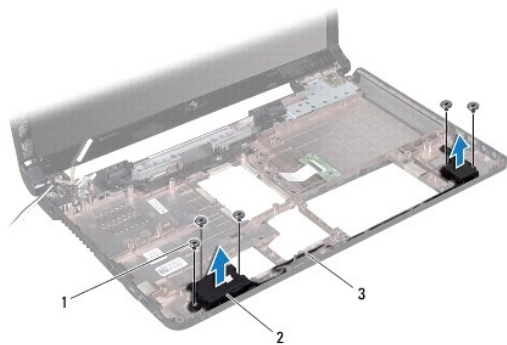

1	screws (5)	2	speakers (2)
3	speaker cable routing		

---

## Replacing the Speakers

1. Follow the procedures in [Before You Begin](#).
2. Place the speakers in the computer base.
3. Route the speaker cable in the routing guides on the computer base.
4. Replace the five screws that secure the two speakers to the computer base.
5. Follow the instructions from [step 5](#) to [step 24](#) in [Replacing the System Board](#).

 **CAUTION:** Before turning on the computer, replace all screws and ensure that no stray screws remain inside the computer. Failure to do so may result in damage to the computer.

---

[Back to Contents Page](#)

## System Board

### Dell™ Inspiron™ 1564 Service Manual

- [Removing the System Board](#)
- [Replacing the System Board](#)
- [Entering the Service Tag in the BIOS](#)

**⚠ WARNING:** Before working inside your computer, read the safety information that shipped with your computer. For additional safety best practices information, see the Regulatory Compliance Homepage at [www.dell.com/regulatory\\_compliance](http://www.dell.com/regulatory_compliance).

**⚠ CAUTION:** Only a certified service technician should perform repairs on your computer. Damage due to servicing that is not authorized by Dell™ is not covered by your warranty.

**⚠ CAUTION:** To avoid electrostatic discharge, ground yourself by using a wrist grounding strap or by periodically touching an unpainted metal surface.

**⚠ CAUTION:** To help prevent damage to the system board, remove the main battery (see [Removing the Battery](#)) before working inside the computer.

---

## Removing the System Board

1. Follow the procedures in [Before You Begin](#).
2. Remove the battery (see [Removing the Battery](#)).
3. Remove the optical drive (see [Removing the Optical Drive](#)).
4. Remove the module cover (see [Removing the Module Cover](#)).
5. Remove the coin-cell battery (see [Removing the Coin-Cell Battery](#)).
6. Remove the memory module(s) (see [Removing the Memory Module\(s\)](#)).
7. Remove the Mini-Card (see [Removing the Mini-Card](#)).
8. Note the routing of the Mini-Card antenna cables and remove them from the routing guides on the bottom of the computer.
9. Remove the hard drive (see [Removing the Hard Drive](#)).
10. Remove the power button panel (see [Removing the Power Button Panel](#)).
11. Remove the keyboard (see [Removing the Keyboard](#)).
12. Remove the palm rest (see [Removing the Palm Rest](#)).
13. Remove the Bluetooth® card (see [Removing the Bluetooth Card](#)).
14. Remove the processor fan (see [Removing the Processor Fan](#)).
15. Disconnect the following cables from their connectors on the system board:
  - 1 microphone cable
  - 1 AC adapter connector cable
  - 1 display cable
  - 1 speaker cable
16. Lift the connector latch and slide the USB/audio cable out of the connector on the system board.
17. Lift the connector latch and slide the optical drive board cable out of the connector on the system board.

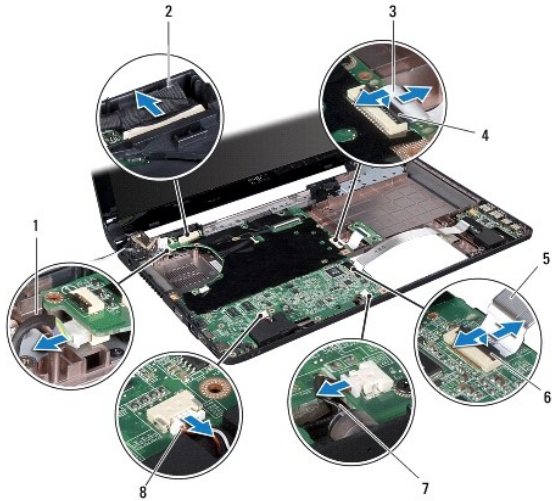

1	AC adapter connector cable	2	display cable
3	optical drive board cable	4	connector latch
5	USB/audio cable	6	connector latch
7	microphone cable	8	speaker cable

18. Remove the six screws that secure the system board to the computer base.

19. Carefully ease the connectors out of the slots in the computer, and lift the system board out of the computer base.

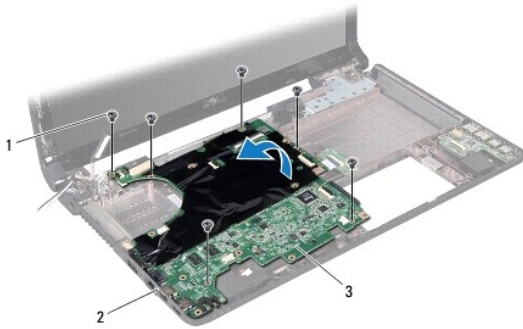

1	screws (6)	2	connectors (4)
3	system board		

20. Turn the system board over.

21. Remove the processor heat sink (see [Removing the Processor Heat Sink](#)).

22. Remove the processor module (see [Removing the Processor Module](#)).

## Replacing the System Board

1. Follow the procedures in [Before You Begin](#).

2. Replace the processor module (see [Replacing the Processor Module](#)).

3. Replace the processor heat sink (see [Replacing the Processor Heat Sink](#)).

4. Turn the system board over.
5. Align the connectors on the system board with the slots on the computer base.
6. Use the alignment posts on the computer base to correctly place the system board.
7. Replace the six screws that secure the system board to the computer base.
8. Slide the optical drive board cable into the connector on the system board, and press down on the connector latch to secure the cable.
9. Slide the USB/audio cable into the connector on the system board, and press down on the connector latch to secure the cable.
10. Connect the following cables to their connectors on the system board:
  1. speaker cable
  1. display cable
  1. AC adapter connector cable
  1. microphone cable
11. Replace the processor fan (see [Replacing the Processor Fan](#)).
12. Replace the Bluetooth card (see [Replacing the Bluetooth Card](#)).
13. Replace the palm rest (see [Replacing the Palm Rest](#)).
14. Replace the keyboard (see [Replacing the Keyboard](#)).
15. Replace the power button panel (see [Replacing the Power Button Panel](#)).
16. Replace the hard drive (see [Replacing the Hard Drive](#)).
17. Replace the Mini-Card (see [Replacing the Mini-Card](#)).
18. Replace the memory module(s) (see [Replacing the Memory Module\(s\)](#)).
19. Replace the coin-cell battery (see [Replacing the Coin-Cell Battery](#)).
20. Replace the module cover (see [Replacing the Module Cover](#)).
21. Replace the optical drive (see [Replacing the Optical Drive](#)).
22. Replace the battery (see [Replacing the Battery](#)).

 **CAUTION:** Before turning on the computer, replace all screws and ensure that no stray screws remain inside the computer. Failure to do so may result in damage to the computer.

23. Turn on the computer.

 **NOTE:** After you have replaced the system board, enter the computer's Service Tag into the BIOS of the replacement system board.

24. Enter the service tag (see [Entering the Service Tag in the BIOS](#)).

---

## Entering the Service Tag in the BIOS

1. Ensure that the AC adapter is plugged in and that the main battery is installed properly.
  2. Turn on the computer.
  3. Press <F2> during POST to enter the system setup program.
  4. Navigate to the security tab and enter the service tag in the **Set Service Tag** field.
-

[Back to Contents Page](#)

[Back to Contents Page](#)

## Dell™ Inspiron™ 1564 Service Manual



**NOTE:** A NOTE indicates important information that helps you make better use of your computer.



**CAUTION:** A CAUTION indicates either potential damage to hardware or loss of data and tells you how to avoid the problem.



**WARNING:** A WARNING indicates a potential for property damage, personal injury, or death.

Information in this document is subject to change without notice.  
© 2009 Dell Inc. All rights reserved.

Reproduction of these materials in any manner whatsoever without the written permission of Dell Inc. is strictly forbidden.

Trademarks used in this text: *Dell*, the *DELL* logo, and *Inspiron* are trademarks of Dell Inc.; *Bluetooth* is a registered trademark owned by Bluetooth SIG, Inc. and is used by Dell under license; *Microsoft*, *Windows*, *Windows Vista*, and the *Windows Vista* start button logo are either trademarks or registered trademarks of Microsoft Corporation in the United States and/or other countries.

Other trademarks and trade names may be used in this document to refer to either the entities claiming the marks and names or their products. Dell Inc. disclaims any proprietary interest in trademarks and trade names other than its own.

December 2009 Rev. A00

---

[Back to Contents Page](#)

## USB/Audio Board

### Dell™ Inspiron™ 1564 Service Manual

- [Removing the USB/Audio Board](#)
- [Replacing the USB/Audio Board](#)

- ⚠ WARNING:** Before working inside your computer, read the safety information that shipped with your computer. For additional safety best practices information, see the Regulatory Compliance Homepage at [www.dell.com/regulatory\\_compliance](http://www.dell.com/regulatory_compliance).
- ⚠ CAUTION:** Only a certified service technician should perform repairs on your computer. Damage due to servicing that is not authorized by Dell™ is not covered by your warranty.
- ⚠ CAUTION:** To avoid electrostatic discharge, ground yourself by using a wrist grounding strap or by periodically touching an unpainted metal surface.
- ⚠ CAUTION:** To help prevent damage to the system board, remove the main battery (see [Removing the Battery](#)) before working inside the computer.
- 

## Removing the USB/Audio Board

1. Follow the procedures in [Before You Begin](#).
2. Remove the battery (see [Removing the Battery](#)).
3. Remove the optical drive (see [Removing the Optical Drive](#)).
4. Remove the module cover (see [Removing the Module Cover](#)).
5. Remove the power button panel (see [Removing the Power Button Panel](#)).
6. Remove the keyboard (see [Removing the Keyboard](#)).
7. Remove the palm rest (see [Removing the Palm Rest](#)).
8. Lift the connector latch and slide the USB/audio cable out of the connector on the USB/audio board.
9. Remove the screw that secures the USB/audio board to the computer base.
10. Lift the USB/audio board and ease the USB and audio connectors out of the computer base.

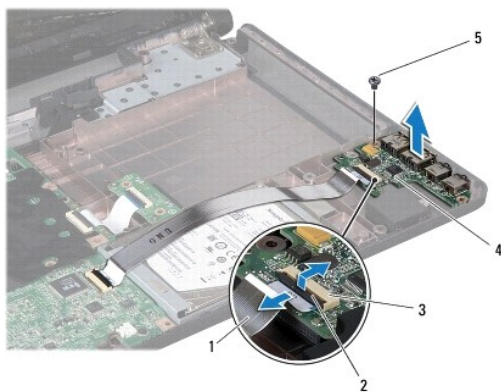

1	USB/audio cable	2	connector latch
3	connector on USB/audio board	4	USB/audio board
5	screw		

---

## Replacing the USB/Audio Board



1. Follow the procedures in [Before You Begin](#).
2. Align the connectors on the USB/audio board with the slots on the computer base.
3. Use the alignment posts on the computer base to correctly place the USB/audio board.
4. Replace the screw that secures the USB/audio board to the computer base.
5. Slide the USB/audio cable into the connector on the USB/audio board, and press down on the connector latch to secure the cable.
6. Replace the palm rest (see [Replacing the Palm Rest](#)).
7. Replace the keyboard (see [Replacing the Keyboard](#)).
8. Replace the power button panel (see [Replacing the Power Button Panel](#)).
9. Replace the module cover (see [Replacing the Module Cover](#)).
10. Replace the optical drive (see [Replacing the Optical Drive](#)).
11. Replace the battery (see [Replacing the Battery](#)).

 **CAUTION:** Before turning on the computer, replace all screws and ensure that no stray screws remain inside the computer. Failure to do so may result in damage to the computer.

---

[Back to Contents Page](#)